

CUSTOMER : _____

DATE: 2010-10-10

SPECIFICATION

PRODUCT: AC/DC ADAPTER

MODEL NO. QIW-12W-1210T

SPEC NO. C001-012

VERSION : A1

RoHS COMPLIANT



Receiver's stamp or signature

**PLEASE APPROVE & RETURN BEFORE 2010-10-25
OR WE WOULD REGARD IT BEEN CONFIRMED.**

RESPONSIBLE	APPROVED	ISSUED
Thomson	Aiwei	Anni

ISSUES STAMP

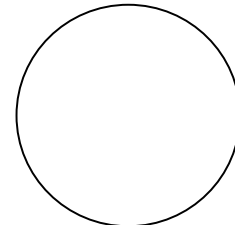

Revised History

NO.	Revised Date	Description	Approved	Issued

Qiw Power Supply Co., Limited

CHINA:

Http://www.qiw.com

E-mail: qiw@qiw.com

TEL : +86-755-89809888 33034333

FAX : +86-755-85522111

HONG KONG:

Http://www.qiw.com.hk

E-mail: qiw@qiw.com.hk

TEL : +852-65548111

FAX : +852-83437988

	DESCRIPTION	AC/DC ADAPTER	SHEET	1 OF 4
	MODEL NO.	QIW-12W-1210T	VERSION:	A1
			SPEC NO.	C001-012

1.INPUT REQUIREMENT

2.OUTPUT SPECIFICATION

3.MECHANICAL

4.RELIABILITY

5.ENVIRONMENT

6.OUTLOOKING

7.SAFETY

8.QC CHECK

9.DIMENSION

10.LABEL

11.PACKING

	DESCRIPTION	AC/DC ADAPTER	SHEET NO.	2 OF 4
	MODEL NO.	QIW-12W-1210T	VERSION:	A1
			SPEC NO.	C001-012

1.INPUT REQUIREMENT

ITEM	SPECIFICATION	MIN	TYP.	MAX
NORMAL AC INPUT VOLTAGE	SINGLE PHASE	100Vac	110Vac/230Vac	240Vac
AC INPUT VOLTAGE RANGE	SINGLE PHASE	90Vac	110Vac/230Vac	264Vac
AC INPUT FREQUENCY	SINGLE PHASE	47Hz	50/60Hz	63Hz
AC INPUT CURRENT	TYPICAL INPUT VOLTAGE& OUTPUT AT FULL LOAD.			300mA
AC INRUSH CURRENT	TYPICAL INPUT VOLTAGE& OUTPUT AT FULL LOAD , 25°C.			30A
EFFICIENCY	TYPICAL INPUT VOLTAGE& OUTPUT AT FULL LOAD	70%		

2.OUTPUT SPECIFICATION

ITEM	SPECIFICATION	MIN	TYP.	MAX
NORMAL DC OUTPUT VOLTAGE			12.0Vdc	
DC OUTPUT VOLTAGE RANGE	TYPICAL OUTPUT VOLTAGE $\pm 5\%$	11.40V		12.60V
LOAD CURRENT RANGE		0.1A		1.0A
PEAK LOAD CURRENT	TIME<60S			1.1A
RIPPLE	TYPICAL INPUT VOLTAGE , TYPICAL LOAD CURRENT , 25°C			120mV
HOLD-UP TIME	AT TYPICAL INPUT VOLTAGE AND FULL LOAD	10mS		
TURN-ON DELAY	TYPICAL INPUT VOLTAGE AND TUP LOAD CURRENT			1S
OVER CURRENT PROTECTION	AUTO RECOVERY			
SHORT CIRCUIT PROTECTRON	THE ADAPTER SHALL NOT DAMAGE BY SHORT THE DC OUTPUT TO GROUND			
NO LOAD POWER DISSIPATION				0.3W
OVER VOLTAGE PROTECTION			14V	18.0V

*TEST MEASURES

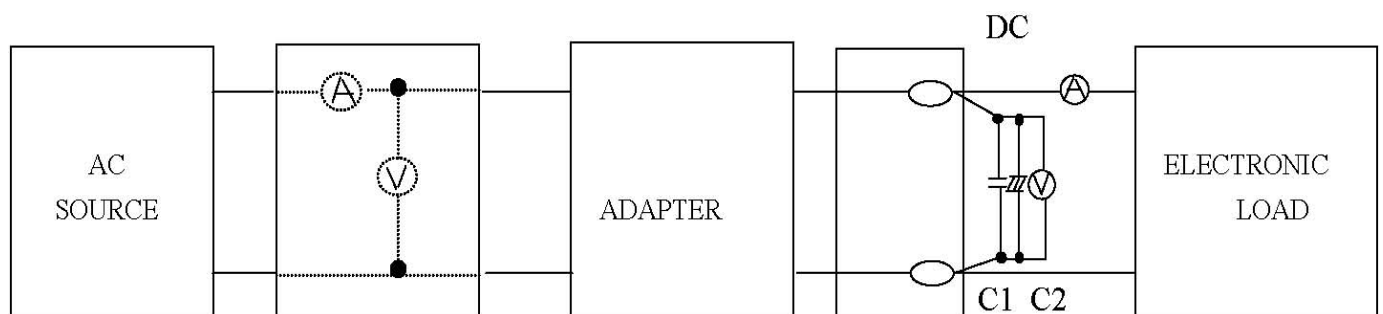

C1: 0.1uF CERAMICS CAPACITOR

C2: 10uF 50V ALUMINUM CAPACITOR

	DESCRIPTION	AC/DC ADAPTER	SHEET NO.	3 OF 4
			VERSION:	A1
	MODEL NO.	QIW-12W-1210T	SPEC NO.	C001-012

3.MECHANICAL

ITEM	SPECIFICATION OR TEST CONDITION	ACCEPTANCE CRITERIA
BENDING TEST	NORMAL TEMPERATURE THE CORD SHALL WITHSTAND WEIGHT OF 200g, SWINGING FROM LEFT TO RIGHT AT AN ANGLE OF 60 DEG. 1000CYCLE TIMES MIN. S/R SHALL WITHSTAND WEIGHT OF 1N. SWINGING FROM LEFT TO RIGHT AT AN ANGLE OF 60DEG. 1000CYCLE TIMES MIN. BENDING SPEED 40CYCLE/MINUTE	NO SHORT CIRCUIT NO BREAKAGE OF THE CORD
VIBRATION	FREQUENCY RANGE:10~55Hz AMPLITUDE:1.5mm ACCELERATION: 1G SWEEP 1 MINUTE FOR X,Y,Z,AXIS EACH	THERE SHALL BENO ABNORMALITY ON THE APPEARANCE STRUCTURE AND OPERATING

4.RELIABILITY

ITEM	TEST CONDITION	ACCEPTANCE CRITERIA
TEMPERATURE UP WITH TYPICAL LOAD	TEST AT SURFACE OF THE CASE WITH TYPICAL AC INPUT AND TYPICAL LOAD IN OUTPUT	TEMPERATURE UP UNDER 35 DEGREES
	50/60Hz	
HI-POT TEST	INPUT TO OUTPUT GRADUALLY RAISED FROM 0 TO THE 3000Vac AND HELD AT THAT VALUE FOR 3S,5mA	NO DAMAGE
MTBF	TYPICAL INPUT&FULL LOAD , 25°C	50000 HOURS
LIFE	TYPICAL INPUT&FULL LOAD, 40°C TYPICAL INPUT&FULL LOAD, 25°C	1YEARS ABOVE 2YEARS ABOVE
BURN-IN	AT 30°C(±10°C),NORMAL INPUT VOLTAGE	2~4 HOURS

5.ENVIRONMENT

ITEM	SPECIFICATION OR TEST CONDITION	min.	typ.	max.
OPERATING TEMPERATURE		0°C		40°C
STORAGE TEMPERATURE		-20°C		85°C
OPERATING HUMIDITY	NON-CONDENSING	5%RH		90%RH
STORAGE HUMIDITY	NON-CONDENSING	5%RH		90%RH

	DESCRIPTION	AC/DC ADAPTER	SHEET NO.	4 OF 4
			VERSION:	A1
	MODEL NO.	QIW-12W-1210T	SPEC NO.	C001-012

6.OUTLOOKING

DIMENSION :60(L)X44(W)X26(H)mm
 WEIGHT :ABOUT 100g
 AC INPUT TYPE :WALL MOUNT
 DC OUTPUT TYPE :5.5x2.1x10mm S TYPE



DC OUTPUT CABLE :2468 22AWG 1800mm
 INDICATION :LABEL
 CASE MATERIAL :94V-0 ABS+PC
 PCB MATERIAL :94V-0

7.SAFETY

COMPLY SAFETY STANDARDS	STANDARD	FILE NO.
UL CUL		
PSE		
GS		

EMI
FCC CE

8.QC CHECK

ALL OF THE QUANTITY SHALL BE CHECKED BEFORE SHIPMENT,CHECK ITEM AS BELOW:
 (1)DC PLUG POLE CHECK
 (2)OCP FUNCTION CHECK
 (3)DC OUTPUT VOLTAGE CHECK
 (4)HIPOT&INSULATION CHECK
 (5)OUTLOOKING CHECK

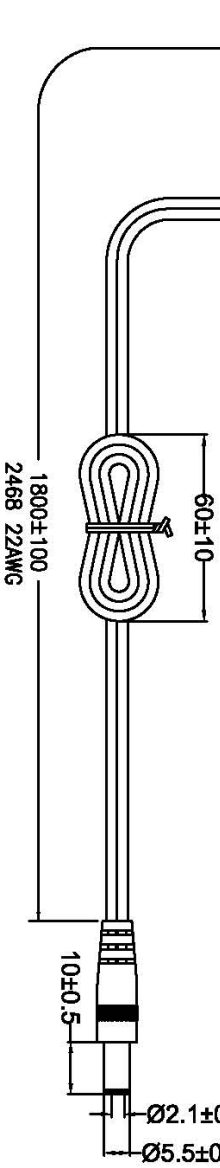
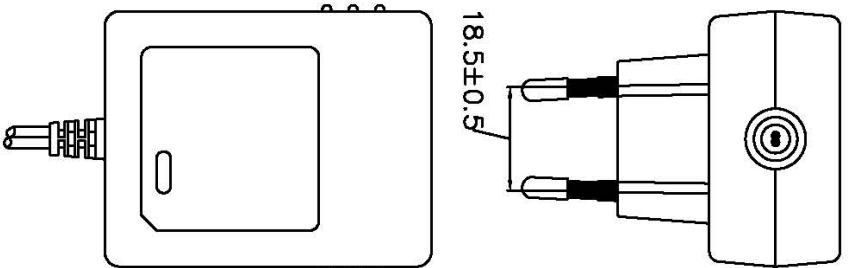
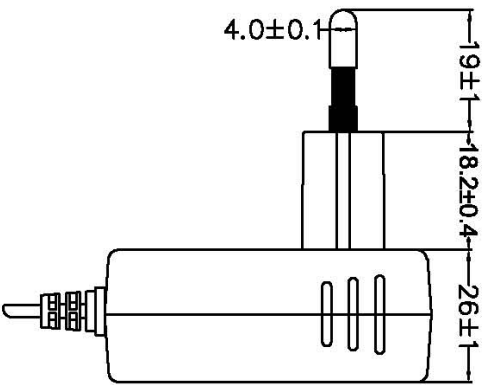
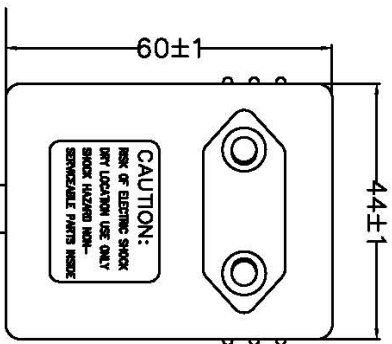

TOLERANCE		±0.1	±0.2	±0.3	±0.4	±0.5
L<4	±0.08	±0.1	±0.2	±0.3	±0.4	±0.5
4<L<20	±0.08	±0.1	±0.2	±0.3	±0.4	±0.5
20<L<50	±0.1	±0.15	±0.2	±0.3	±0.4	±0.5
50<L<200	±0.15	±0.25	±0.3	±0.4	±0.5	±0.6
200<L	±0.2	±0.4	±0.5	±0.6	±0.7	±0.8

FINISH	MATERIAL	UNIT	REV.
XXXXXX	XXX	mm	A1

NAME	PART NO.

DRG.	CHRD.	APPL.	SCALE	UNIT	REF. DWG NO.	REV.
Anni				mm	XXXX	XXXX

SCALE	UNIT	REF. DWG NO.	REV.
	mm	XXXX	XXXX

NAME	PART NO.

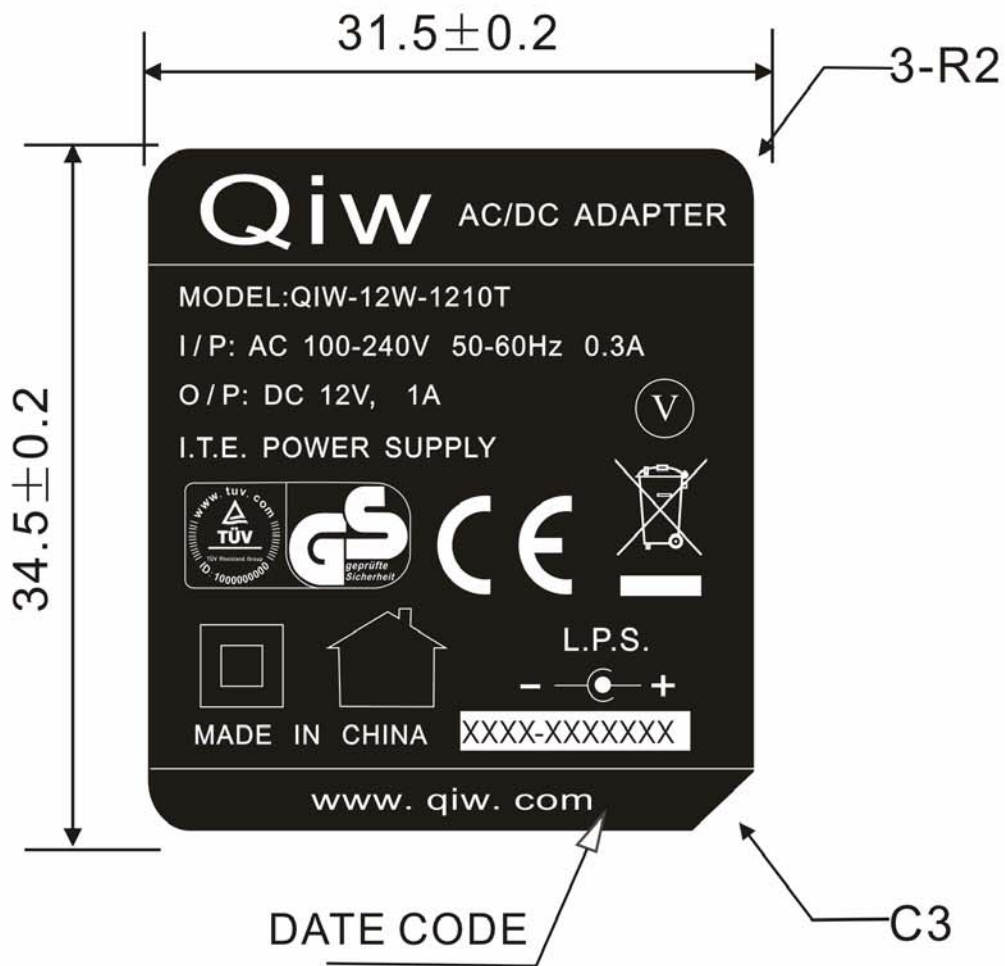

XXXX-XXXXXXX



NOTE:

- 1.SILVER WORD ON BLACK BASE.
- 2.MATERIAL:PVC + MYLAR FILM.

TOLERANCE					FINISH	NAME: LABEL	
L ≤ 4	0.05	0.08	0.1	0.2		MATERIAL	QTY.
4 < L ≤ 20	0.08	0.1	0.2	0.3	A1		
20 < L ≤ 50	0.1	0.15	0.3	0.4	UNIT	mm	PART NO.
50 < L ≤ 200	0.15	0.25	0.4	0.6			
200 < L	0.2	0.4	0.5	0.8	SCALE	REF.	REM.
DEG.	CHKD.	APPD.	UNIT	mm	REF.	REM.	
Anni	Aiwei	Thomson					

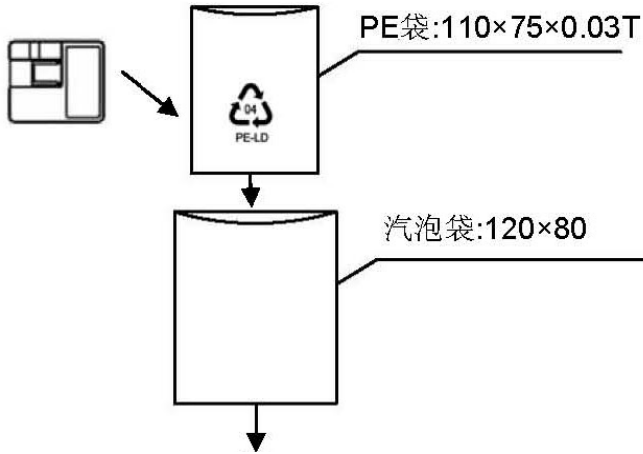

注:PE袋和汽泡袋不要用胶纸固定

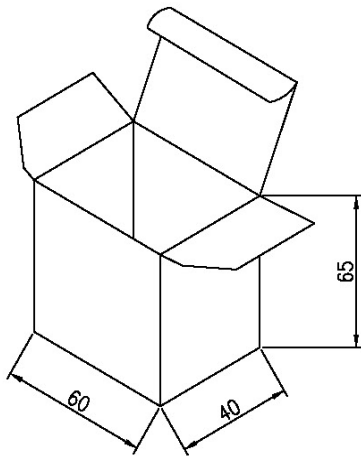

小白盒 500g

外徑寸法 長X寬X高

60x40x65

TOLERANCE:±1

一个小白盒内放一个产品

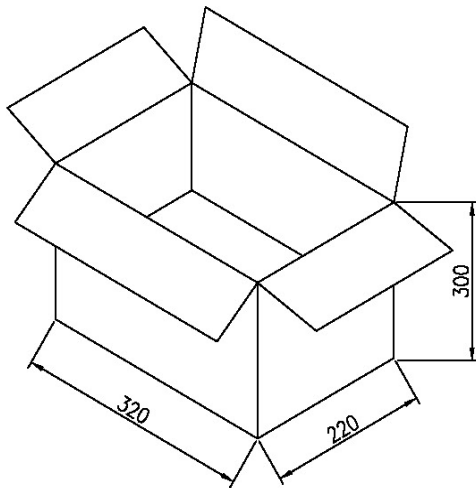

外箱:(K=K)

成品100PCS 放入

外徑寸法 長X寬X高

320X220X300

TOLERANCE:±3

TOLERANCE					FINISH				NAME	PACKING
L≤4	4<L≤20	20<L≤50	50<L≤200	200<L		MATERIAL	REV.	A1		
±0.05	±0.08	±0.1	±0.2	±0.3						
±0.08	±0.1	±0.2	±0.3	±0.4						
±0.1	±0.15	±0.3	±0.4	±0.6						
±0.15	±0.25	±0.4	±0.6	±0.8						
±0.2	±0.4	±0.5	±0.8							
DEG.	CHKD.	APPD.	UNIT		mm			PART NO.	C001-012	
			SCALE	REF.						
Anni				DWG NO.						